



USER'S MANUAL

solar Inverter/Charger



USER'S MANUAL

SOLAR INVERTER/CHARGER

RSI-LF-PLUS SERIES

Appliances



PC



TV



Air-conditioning



Fridge



Washing machine

Table of Contents

	(default)						
	Over charge disconnection	14.8VDC for12VDC mode					
	Over charge recovery	13.6VDC for12VDC mode					
	Over discharge disconnection	10.8VDC for12VDC mode					
	Over discharge reconnection	12.3VDC for12VDC mode					
	Temperature compensation	-13.2mVDC/°C for12VDC mode					
	Ambient temperature	0-40°C (full load) 40-60°C (derating)					
Mechanical specifications	Mounting	Wall mount					
	Inverter dimensions (L*W*H)	620*385*215mm			670*410*215mm		
	Inverter weight (solar chg) KG	36	41	44	66.5 +2.5	72.5 +2.5	72.5 +2.5
	Shipping dimensions (L*W*H)	755*515*455mm			884*618*443mm		
	Shipping weight (solar chg) KG	56	61	64	89 +2.5	95 +2.5	95 +2.5
	Display	Status LEDs / status LEDs + LCD					
	Standard warranty	1 years					

Important Safety Information 1

 General Safety Precautions 1

 Precautions When Working with Batteries 1

General Information 2

Application 3

Features 3

Basic System Architecture 4

Product Overview 4

Installation 5

 Unpacking and Inspection 5

 Preparation 6

 Mounting The Unit 6

 Battery Connection 7

 AC Input/Output Connection 8

 PV Connection 11

Electrical Performance 12

LCD Display Icons 21

Operating Mode Description 23

Display Data 24

Warning code 26

Audible Alarm 29

DIP Switches 30

Appendix 1 33

Important Safety Information



WARNING!

This manual contains important instructions for all Inverter/Charger models that shall be followed during installation and maintenance of the inverter.

General Safety Precautions

1. Before installing and using the Inverter/Charger, read all instructions and cautionary markings on the Inverter/Charger and all appropriate sections of this guide be sure to read all instructions and cautionary markings for any equipment attached to this unit.
2. This unit is designed for indoor use only. Do not expose the Inverter/Charger to rain, snow, or spray.
3. To reduce risk of fire hazard, do not cover or obstruct the ventilation openings. Do not install the Inverter/Charger in a zero-clearance compartment. Otherwise overheating may occur.
4. Use only attachments recommended or sold by the manufacturer. Doing otherwise may result in a risk of fire, electric shock, or injury to persons.
5. To avoid a risk of fire and electric shock, make sure that existing wiring is in good condition and that wire is not undersized. Do not connect the Inverter/Charger with damaged or substandard wiring.
6. Do not operate the Inverter/Charger if it has received a sharp blow, been dropped, or otherwise damaged in any way. If the Inverter/Charger is damaged, read the Warranty section.
7. Do not disassemble the Inverter/charger. It contains no user-serviceable parts. See Warranty for instructions on obtaining service. Attempting to service the Inverter/Charger yourself may result in a risk of electrical shock or fire. Internal capacitors remain charged after all power is disconnected.
8. The Inverter contains more than one live circuits(batteries and AC line). Power may be present at more than one source. To reduce the risk of electrical shock, disconnect both AC and DC power from the Inverter/Charger before attempting any maintenance or cleaning or working on any circuits connected to the Inverter/Charger. Turning off controls will not reduce this risk.
9. Use insulated tools to reduce the chance of short-circuits when installing or working with the inverter, the batteries, or PV array.

Precautions When Working with Batteries

1. Make sure the batteries are well ventilated to the environment around.
2. Never smoke or allow a spark or flame near the engine or batteries.
3. Use caution to reduce the risk of dropping a metal tool on the battery. It could spark or short circuit the battery or other electrical parts and could cause an explosion.
4. Remove all metal items, like rings, brace lets, and watches when working with lead-acid batteries. Lead-acid batteries produce a short circuit current high enough to weld metal to skin, causing a severe burn.
5. Make sure someone is close enough to aid you if danger occur when you're working near a lead-acid battery.

	Max charge power rate	1/3 Rating power (refer to table 2.5.3)		
	Battery initial voltage for start	10-15.7VDC for 12VDC mode	*2 for 24VDC, *4 for 48VDC	
	Over charge protection S.D.	15.7VDC for 12VDC mode		
BTS	Battery temperature sensor (optional)	Variances in charging voltage & S.D. voltage base on the battery temperature.		
Bypass & protection	Input voltage waveform	Sine wave (grid or generator)		
	Nominal voltage	230VAC		
	Max input AC voltage	300VAC for 230VAC HV mode.		
	Nominal input frequency	50Hz or 60Hz		
	Low freq trip	47 ± 0.3Hz for 50Hz; 54.5 ± 0.3Hz for 60Hz		
	High freq trip	55.5 ± 0.3Hz for 50Hz; 64.5 ± 0.3Hz for 60Hz		
	Overload protection (SMPS load)	Circuit breaker		
	Output short circuit protection	Circuit breaker		
	Bypass breaker rating	40	80	
	Transfer switch rating	40Amp	80Amp	
	Bypass without battery connected	Yes (optional)		
	Max bypass current	40Amp	80Amp	
	Solar charger (optional)	Rated voltage	12.0VDC / 24.0VDC / 48.0VDC	48.0VDC
Solar input voltage range		15-100VDC / 30-100VDC / 55-100VDC	70-145VDC	
Rated charge current		40-60A	60/120A	
Rated output current		15A		
Self consumption		<10mA		
Bulk charge (default)		14.5VDC for12VDC mode	*2 for 24VDC, *4 for 48VDC	
Floating charge (default)		13.5VDC for12VDC mode		
Equalization charge	14.0VDC for12VDC mode			

Appendix 1

Electrical specifications							
	Model	4.0 KW	5.0 KW	6.0 KW	8.0 KW	10.0 KW	12.0 KW
Inverter output	Continuous output power	4.0 KW	5.0 KW	6.0 KW	8.0 KW	10.0 KW	12.0 KW
	Surge rating (20ms)	12.0 KW	15.0 KW	18.0 KW	24.0 KW	30.0 KW	36.0 KW
	Output waveform	Pure sine wave/ same as input (bypass mode)					
	Nominal efficiency	>85% (peak)			>88% (peak)		
	Line mode efficiency	>95%					
	Power factor	0.9-1.0					
	Nominal output voltage RMS	220-230-240VAC					
	Output voltage regulation	±10% RMS					
	Output frequency	50Hz ±0.3Hz / 60Hz ±0.3Hz					
	Short circuit protection	Yes (1sec after fault)					
	Typical transfer time	10ms (max)					
THD	< 10%						
DC input	Nominal input voltage	12.0VDC / 24.0VDC / 48.0VDC		*2 for 24VDC, *4 for 48VDC			
	Minimum start voltage	10.0VDC/10.5VDC for12VDC-mode					
	Low battery alarm	10.5VDC/ 11.0VDC for12VDC mode					
	Low battery trip	10.0VDC /10.5VDC for12VDC mode					
	High voltage trip	15.0VDC for12VDC mode					
	High battery voltage recover	14.5VDC for12VDC mode					
Idle consumption-search mode	refer to Table 2.5.6						
Charger	Output voltage	Depends on battery type (refer to table 2.5.2)					
	Charger breaker rating	40A			80A		

6. Prepare enough fresh water and soap in case battery acid contacts skin, clothing, or eyes.
7. Wear complete eye protection and clothing protection. Avoid touching your eyes while working near batteries.
8. If battery acid contacts skin or clothing, wash immediately with soap and water. If acid enters your eye, immediately flood it with cold water and get medical attention immediately.
9. If you need to remove a battery, always remove the grounded terminal from the battery first. Make sure all accessories are off so you don't cause a spark.
10. Always use identical types of batteries.
11. Never install old or untested batteries. Check each battery's date code label to ensure age and type.
12. Batteries are temperature sensitive. For optimal performance, they should be installed in a stable temperature environment.
13. Always recycle old batteries. Contact your local recycling center for proper disposal information.

General Information

Thank you for purchasing the Inverter/Charger.

The inverter is a combination of an inverter, charger, solar charger.

It is packed with unique features and it is one of the most advanced inverter/charger in the market today.

The inverter features an AC bypass circuit, powering your home appliances from utility or generator power while charging the battery. When utility power fails, the battery backup system keeps your appliances powered until utility power is restored. Internal protection circuits prevent over-discharge of the batteries by shutting down the inverter when a low battery condition occurs. When utility or generator power is restored, the inverter transfers to the AC source and recharges the batteries.

The series inverter can also serve as a central hub of renewable energy system. Set the series inverter to battery priority mode, designates the inverter-preferred UPS configuration. In this configuration, the load power is normally provided by the inverter. However, if the inverter output is interrupted, an internal transfer switch automatically transfers the load from the inverter to commercial utility power. The transfer time between inverter and line is short (6ms typical), and such transfers are normally not detected by even highly sensitive loads. Upon restoration of Battery capacity, the inverter will transfer back to inverter power.

In the line priority mode, when utility power cuts off (or falls out of acceptable range), the transfer relay is de-energized and the load is automatically transferred to the inverter output. Once the qualified utility power is restored, the relay is energized and the load is automatically reconnected to utility power.

It features power factor correction sophisticated multi-stage charging and pure sine wave output with unprecedentedly high surge capability to meet demanding power needs of inductive loads without endangering the equipment.

The inverter is equipped with a powerful charger of up to 100Amp(depending on Mode). The overload capacity is 120~150% of continuous output for up to 20 seconds to reliably support tools and equipment longer.

Another important feature is that the inverter can be easily customized to solar priority by a DIP switch, this helps to extract maximum power from solar in renewable energy systems.

To get the most out of the power inverter, it must be installed, used and maintained properly. Please read the instructions in the manual before installing and operating.

Application

Power tools-circular saws, drills, grinders,sanders, buffers, weed and hedge trimmers, air compressors.

Office equipment such as computers, printers, monitors, facsimile machines,scanners.

Household items-vacuum cleaners, fans, fluorescent and incandescent lights, shavers, sewing machines.

Kitchen appliances-coffee makers, blenders, ice makers, toasters.

Industrial equipment-metal halide lamp, high-pressure sodium lamp.

Home entertainment electronics-television, VCRs, video games, stereos, musical instruments, satellite equipment.

Features

- Pure sine wave output
- Power range 4KW-12KW
- 24V/48VDC input voltage
- Powerful Charge Rate Up to 100Amp
- Inbuilt pure copper transformer
- LED+LCD display
- MPPT solar charge controller 60A(120A Optional)
- MPPT Efficiency max 98%
- 50/60HZ automatic sensing
- RS485 with free CD
- Battery priority function
- Automatically send signal to start generator
- DC Start & Automatic Self-Diagnostic Function
- High Efficiency Design & "Power Saving Mode" to Conserve Energy

Solar/AC priority:

Our inverter is designed with AC priority by default. This means, when AC input is present, the battery will be charged first, and the inverter will transfer the input AC to power the load. Only when the AC input is stable for a continuous period of 15 days, the inverter will start a battery inverting cycle to protect the battery. After 1 cycle normal charging and ac through put will be restored.

The AC priority and battery priority switch is SW5. When you choose battery priority, the inverter will inverting from battery despite the AC input. Only when the battery voltage is reaches low voltage alarm point (10.5V for 12V).the inverter transfers to AC input, charges battery, and switches back to battery when battery is charged full. This function is mainly for wind/solar systems taking utility power as back up.

Turning SW5 on the DIP switch to position 1, the machine will be solar priority model.

At this model, the load can be fed by the batteries or mains alternately under specific transition condition.

By turning the Battery Type Selector you can change the transition condition in order to match different battery types. All transition conditions are listed below and the numbers stand for the directing of the arrow in the Battery Type Selector.

• From mains feeding to battery feeding

◆NO.1 to NO.8. If the solar is on, the mains charging current should be less than 2AAC, and the solar charging current should be less than 10ADC. If the solar is off, the solar charging current should be less than 10ADC. After achieving these conditions, the machine will transform in 10 minutes.

◆NO.9. If the solar is on, the solar charging current should be less than 10ADC. After achieving this condition, the machine will transform in 10 minutes. If the solar is off, the machine can't transform.

• From battery feeding to mains feeding

◆NO.1 to NO.6. If the single battery voltage is less than 11V DC, the machine will transform immediately.

◆NO.7. If the single battery voltage is less than 11.6V DC, the machine will transform immediately.

◆NO.8. If the single battery voltage is less than 12V DC, the machine will transform immediately.

◆NO.9. If the single battery voltage is less than 12.4V DC, the machine will transform immediately.

Other features

Battery voltage recover start

After low battery voltage shut off (10V for 12V model /20V for 24V model /40V for 48V(model),the inverter is able to restore operation after the battery voltage recovers to 12VDC/24VDC/48VDC (with power switch still in the "On" position). This function helps to save the users extra labor to reactivate the inverter when the low battery voltage returns to an acceptable range in the renewable energy systems. The built in battery charger will automatically reactivate as soon as city/generator ac has been stable for 15 seconds.

Allow at least 80cm of clearance around the inverter for air flow. Make sure that the air can circulate freely around the unit.

Variable speed fan operation is required in invert and charge mode. This is to be implemented in such a way as to ensure high reliability and safe unit and component operating temperatures in an operating ambient temperature up to 40°C.

Speed to be controlled in a smooth manner as a function of internal temperature and /or current.

Fan should not start/stop suddenly.

Fan should run at minimum speed needed to cool unit.

Fan noise level target < 60db at a distance of 1m.

DIP Switches

On the rear panel of inverter, there are 5 DIP switches which enable users to customize the performance of the device.

Table 2.5.11 dip switch function setting

DIP switch NO.	Switch function		Position : 0	Position : 1
SW1	Low battery trip volt		10.0VDC	10.5VDC
			*2 for 24VDC, *4 for 48VDC	
SW2	AC input range	230VAC HV	197-255VAC /(184-272VAC)	167-255 VAC /(154-272VAC)
SW3	Power saver auto setting		Detect load per 5secs	Detect load per 30secs
SW4	O/P frequency setting		50Hz	60Hz
SW5	Solar/AC priority setting		Utility priority	Solar priority

SW1 : Low battery trip volt:

For 12VDC model ,the Low battery trip volt is set at 10.0VDC by typical deep cycle lead acid battery. It can be customized to 10.5VDC using SW1 for sealed car battery, this is to prevent batteries from over-discharging while there is only a small load applied on the inverter. (*2 for 24VDC, *4 for 48VDC)

SW2: AC input range:

There are different acceptable AC input ranges for different kinds of loads.

For some relatively sensitive electronic devices, a narrow input range of 184-272VAC is required to protect them.

While for some resistive loads which work in a wide voltage range, the input AC range can be customized to 154-272VAC , this helps to power loads with the most AC input power without frequent switches to the battery bank.

Power saver auto setting:

The inverter is factory defaulted to detect load for 250ms in every 5 seconds. This cycle can be customized to 30 seconds thru the SW3 on the DIP switch.

Basic System Architecture

The following illustration shows basic application for this inverter. It also includes following devices to have a complete running system:

Generator or Grid.

Battery

PV modules

Consult with your system integrator for other possible system architectures depending on your requirements.

This inverter can power all kinds of appliances in home or office environment, including motor-type appliances such as tube light, fan, refrigerator and air conditioner.

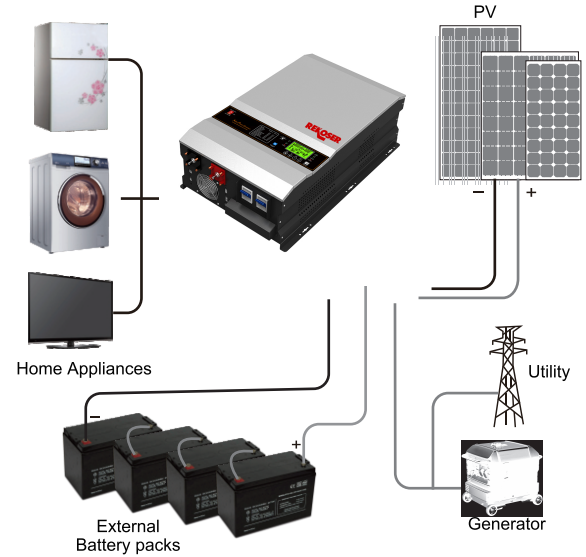

Product Overview

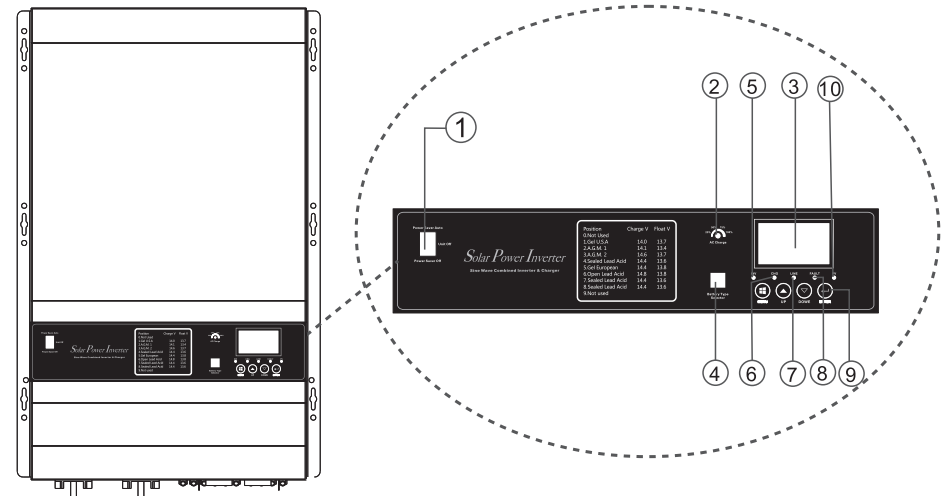

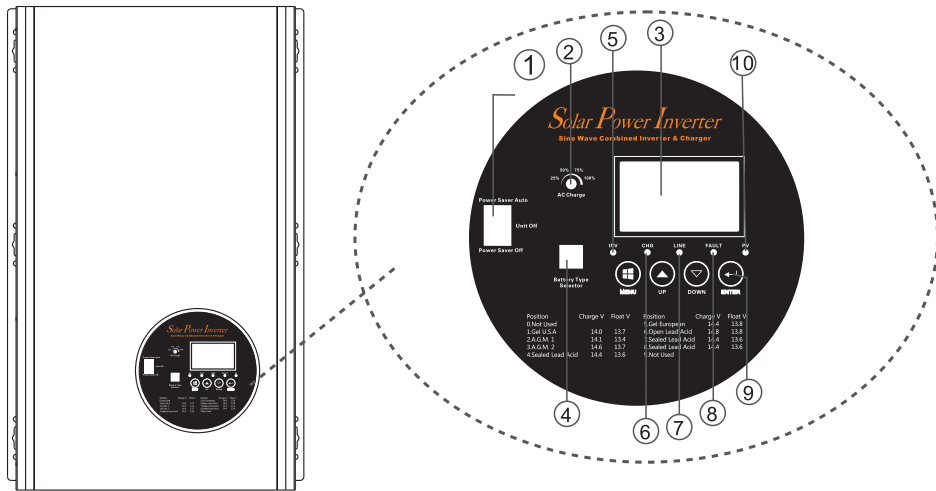

Audible Alarm

Table 2.5.9 audible alarm spec

Battery voltage	Inverter LCD show the error code [E4], and the buzzer beeps 0.5s every 5s.
Battery voltage	Inverter green LCD show the error code [E3], and the buzzer beeps 0.5s every 1s and fault after 60s.
Invert mode over-load (4-10KW)	(1) 100% < load < 105% (±10%). No audible alarm in 20 minutes. Beeps 0.5s every 1s in 20 th minute and fault after 30 minutes. (2) 105% < load < 110% (±10%). No audible alarm in 14 minutes. Beeps 0.5s every 1s in 15 th minute and fault after 15 minutes. (3) 110% < load < 120% (±10%). Beeps 0.5s every 1s and fault after 60s. (4) Load > 120%(±10%). Beeps 0.5s every 1s and fault after 20s.
Invert mode over-load (12KW)	(1) 100% < load < 110% (±10%). Being the same as 4-10kw. (2) Load > 130%. If the load current is higher than 63A AC, the machine will fault immediately.
Over temperature	Heatsink temp. ≥95°C. Over temp red LED lighting. Beeps 0.5s every 1s.

The operation of the DC fan at the DC terminal side is controlled by the following logic (refer to table 2.5.10).

Table 2.5.10 fan operation logic

Condition	Enter condition	Leave condition	speed
Heat sink temperature	$T \leq 45^{\circ}\text{C}$	$T > 45^{\circ}\text{C}$	OFF
	$46^{\circ}\text{C} \leq T < 60^{\circ}\text{C}$	$\leq 46^{\circ}\text{C} / T \geq 60^{\circ}\text{C}$	50%
	$T > 60^{\circ}\text{C}$	$\leq 60^{\circ}\text{C}$	100%
Charger current	$I \leq 16\%$	$I \geq 16\%$	OFF
	$17\% < I \leq 50\%$	$I \leq 17\% / I \geq 50\%$	50%
Load % (inv mode)	$I > 50\%$	$I \leq 50\%$	100%
	Load < 16%	Load ≥ 16%	OFF
	$16\% \leq \text{Load} < 37.5\%$	Load ≤ 16% / Load ≥ 37.5%	50%
	Load ≥ 37.5%	Load ≤ 37.5%	100%

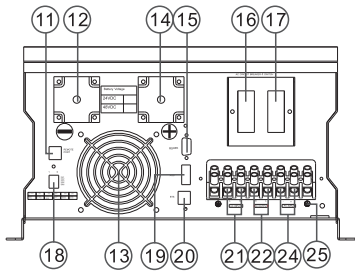

4-6KW

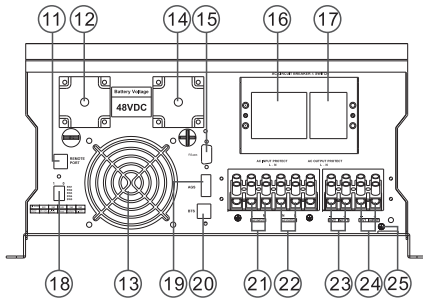

8-12KW

1. Power saver on/off switch
2. AC Charger current Setting
3. LCD display
4. Battery Voltage Setting
5. Inverter indicator
6. Charging indicator
7. Grid indicator
8. Fault indicator
9. Function
10. PV indicator
11. Remote control port
12. BAT "+"
13. FAN
14. BAT "+"
15. RS485/CAN communication port
16. AC input/Bypass breaker
17. AC output breaker
18. Function Switch(SW1-SW5)
19. AGS (Auto Generator Start)
20. BTS
21. AC input
22. AC OUTPUT
23. PV2 input(Optional)
24. PV1 input
25. Ground



WARNING

Never leave the loads unattended, some loads (like a heater) may cause accident in such cases. It is better to shut everything down after low voltage trip than to leave your load on, due to the risk of fire.

Symptom	Possible cause	Recommended solution
Inverter will not turn on during initial power up.	Batteries are not connected, loose battery-side connections. Low battery voltage.	Check the batteries and cable connections check DC fuse and breaker. Charge the battery.
No AC output voltage and no indicator lights ON.	Inverter has been manually transitioned to OFF mode.	Press the switch to power saver on or power saver off position.
AC output voltage is low and the inverter turns loads OFF in a short time.	Low battery.	Check the condition of the batteries and recharge if possible.
Charger is inoperative and unit will not accept AC.	AC voltage has dropped out-of-tolerance.	Check the AC voltage for proper voltage and frequency.
Charger is supplying a lower charge rate.	Charger controls are improperly set. Low AC input voltage. Loose battery or AC input connections.	Refer to the section on adjusting the "Charger Rate" Source qualified AC power. Check all DC/AC connections.
Charger turns OFF while charging from a generator.	High AC input voltages from the generator.	Load the generator down with a heavy load. Turn the generator output voltage down.
Sensitive loads turn off temporarily when transferring between grid and inverting.	voltage may be too to sustain certain loads.	Choose narrow AC voltage in the DIP switch, or install a UPS if possible.
Noise from transformer/case*.	Applying specific loads such as hair drier.	Remove the loads.

INSTALLATION

Unpacking and Inspection

Before installation, please inspect the unit. Be sure that nothing inside the package is damaged. You should have received the following items inside of package:

- The unit x 1
- User manual x 1
- CD x 1
- RS485 Line x 1 (Option)
- BTS Line x 1 (Option)
- Remote Line x 1 (Option)
- RS232 Line x 1

Preparation

Before connecting all wirings, please take off bottom cover by removing eight screws as shown below

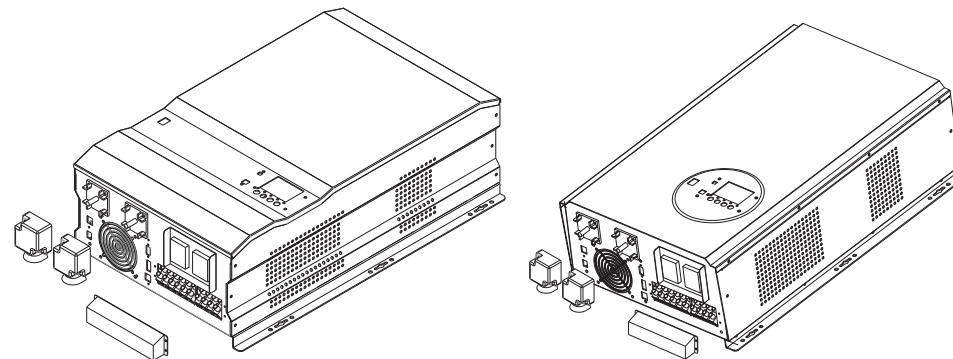

Mounting the Unit

Consider the following points before selecting where to install:

- Do not mount the inverter on flammable construction materials.
- Mount on a solid surface.
- Install this inverter at eye level in order to read the LCD display clearly.
- For proper air circulation to dissipate heat, require a clearance about 50 cm to the side and 80 cm above and below the unit.
- The ambient temperature should be between 0°C and 40°C to ensure optimal operation.
- The recommended installation position is to be adhered to the wall vertically.
- Be sure to keep other objects and surfaces as shown in the diagram to guarantee sufficient heat dissipation and to have enough space for removing wires.

! SUITABLE FOR MOUNTING ON CONCRETE OR OTHER NON-COMBUSTIBLE SURFACE ONLY.

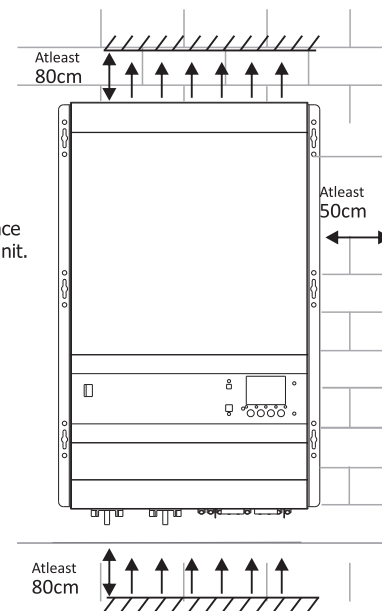

Install the unit by screwing four screws

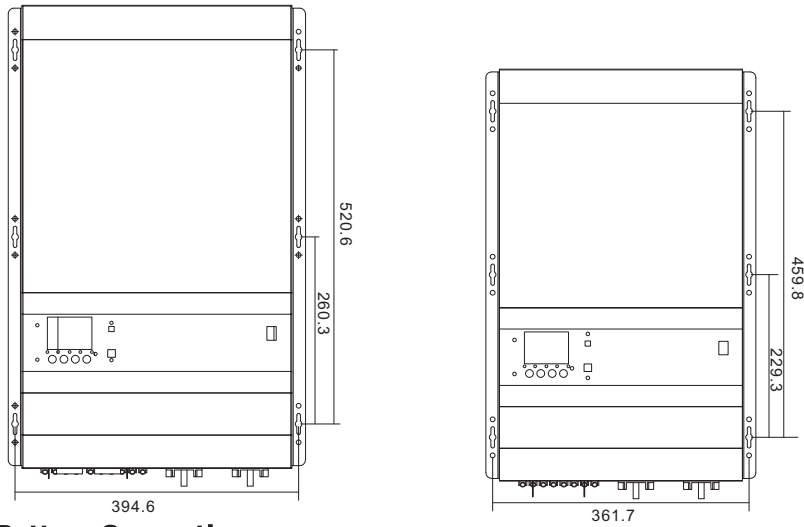

Battery Connection

CAUTION: For safety operation and regulation compliance, it's requested to install a separate DC over-current protector between battery and inverter. It may not be requested to have a disconnect device in some applications, however, it's still requested to have over-current protection installed. Please refer to typical amperage in below table as required fuse or breaker size.













DC Wiring recommendation

It is suggested the battery bank be kept as close as possible to the inverter. The following cable is a suggested wiring option for 1 meter DC cable.

Please find the following minimum wire size. In case of DC cable longer than 1m, please increase the cross section of cable to reduce the loss.

Model	Battery Voltage	Wire gage/Min		Model	Battery Voltage	Wire gage/Min	
		0-1.0m				0-1.0m	
4KW	24VDC	2*2AWG		5KW	24VDC	2*1AWG	
	48VDC	1*2AWG			48VDC	1*1AWG	
6KW	24VDC	3*2AWG		8KW	24VDC		
	48VDC	2*3AWG			48VDC	2*2AWG	
10KW	48VDC	2*1AWG		12KW	48VDC	3*2AWG	

Warning Code	Warning Event	Audible Alarm	Icon Flashing
61	Fan is locked when inverter is on.	Beep three times every second	
62	Fan2 is locked when inverter is on.	Beep three times every second	
63	Battery is over-charged.	Beep once every second	
64	Low battery	Beep once every second	
67	Overload	Beep once every 0.5second	
70	Output power derating	Beep twice every 3seconds	
72	Solar charger stops due to low battery.		
73	Solar charger stops due to high PV voltage.		
74	Solar charger stops due to over load.		
75	Solar charger over temperature		
76	PV charger communication error		

31	Solar charger battery voltage class error	[31] 
32	Solar charger current sensor error	[32] 
33	Solar charger current is uncontrollable	[33] 
41	Inverter grid voltage is low	[41] 
42	Inverter grid voltage is high	[42] 
43	Inverter grid under frequency	[43] 
44	Inverter grid over frequency	[44] 
51	Inverter over current protection error	[51] 
53	Inverter soft start failed	[53] 
55	Over DC voltage in AC output	[55] 
56	Battery connection is open	[56] 
57	Inverter control current sensor error	[57] 
58	Inverter output voltage is too low	[58] 

One cable is always best, but cable is simply copper and all you require is the copper, so it does not matter if is one cable or 10 cables as long as the square area adds up. Performance of any product can be improved by thicker cable and shorter runs, so if in doubt round up and keep the length as short as possible.

Please follow below steps to implement battery connection:

1. Assemble battery ring terminal based on recommended battery cable and terminal size.
2. Connect all battery packs as units requires. It's suggested to connect , at least 200Ah capacity batter for 4KW-6KW model and at least 400Ah capacity battery for 8KW-12KW model

NOTE: Please only use sealed lead acid battery or sealed GEL/AGM lead-acid battery.

3. Insert the ring terminal of battery cable into battery connector of inverter and make sure the bolts are tightened with torque of 2-3 Nm. Make sure polarity at both the battery and the energy storage inverter is correctly connected and ring terminals are tightly screwed to the battery terminals.

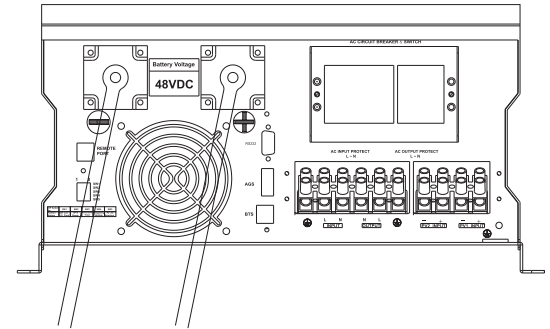

 **WARNING: Shock Hazard**
Installation must be performed with care due to high battery voltage in series.

 **CAUTION!!** Do not place anything between the flat part of the inverter terminal and the ring terminal. Otherwise, overheating may occur.
CAUTION!! Do not apply anti -oxidant substance on the terminals before terminals are connected tightly.
CAUTION!! Before making the final DC connection or closing DC breaker/disconnector, be sure positive (+) must be connected to positive (+) and negative (-) must be connected to negative (-).

AC Input/Output Connection

CAUTION!! Before connecting to AC input power source, please install a separate AC breaker between inverter and AC input power source. This will ensure the inverter can be securely disconnected during maintenance and fully protected from over current of AC input. The recommended spec of AC breaker is 40A for 4kw-6kw, 80A for 8Kw-12Kw.

CAUTION!! Please don't connect the output wiring to "Grid" terminal or connect the grid wiring to the "Load" terminal.

WARNING! All wiring must be performed by a qualified personnel.

WARNING! It's very important for system safety and efficient operation to use appropriate cable for Grid connection. To reduce risk of injury, please use the proper recommended cable size as below.

AC Wiring

We recommend using 10-5Awg wire to the ac terminal block.

There are 3 different ways of connecting to the terminal block depending on the model. All the wirings are CE compliant, call our tech support if you are not sure about how to wire any part of your inverter

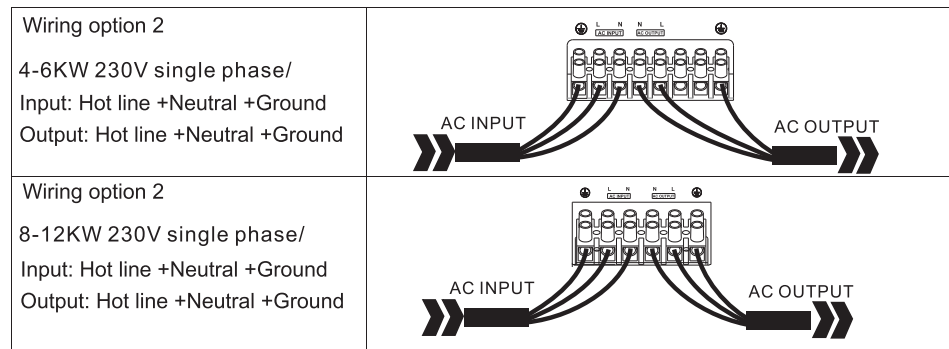

Suggested cable requirement for AC wires

Model	Gauge	Torque Value
4-5KW	10AWG	1.4~1.6Nm
6-8KW	8AWG	1.4~1.6Nm
10-12KW	2*10AWG	1.6~1.8Nm

Warning code

Warning code	Fault Cause	LCD Indication
01	Fan is locked when inverter is off	[01]
02	Inverter transformer over temperature	[02]
03	battery voltage is too high	[03]
04	battery voltage is too low	[04]
05	Output short circuited	[05]
06	Inverter output voltage is high	[06]
07	Overload time out	[07]
21	Inverter output voltage sensor error	[21]
22	Inverter grid voltage sensor error	[22]
23	Inverter output current sensor error	[23]
24	Inverter grid current sensor error	[24]
25	Inverter load current sensor error	[25]
26	Inverter grid over current error	[26]
27	Inverter radiator over temperature	[27]

<p>Load in Watt/VA</p>	
<p>Grid frequency/Inverter frequency</p>	
<p>PV1 voltage and total power</p>	
<p>PV charger output voltage and current (PV2 voltage and total current for PV120A Optional)</p>	

Please follow below steps to implement Load/Grid connection:

1. Before making Load/Grid connection, be sure to open DC protector or disconnecter first.
2. Remove insulation sleeve 10mm for six conductors. And shorten phase L and neutral conductor N 3 mm.
3. Insert grid wires according to polarities indicated on terminal block and tighten the terminal screws. Be sure to connect PE protective conductor (⊕) first.

⊕ → **Ground (yellow-green)**
L → **LINE (brown or black)**
N → **Neutral (blue)**

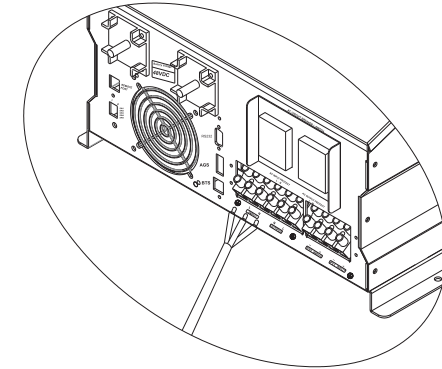

WARNING:
 Be sure that AC power source is disconnected before attempting to hardwire it to the unit.

4. Then, insert Load wires according to polarities indicated on terminal block and tighten terminal screws. Be sure to connect PE protective conductor (⊕) first.

⊕ → **Ground (yellow-green)**
L → **LINE (brown or black)**
N → **Neutral (blue)**

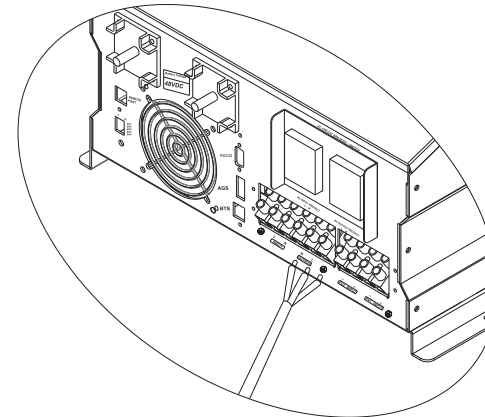

5. Make sure the wires are securely connected.

CAUTION : Appliances such as air conditioner are required at least 2~3 minutes to restart because it's required to have enough time to balance refrigerant gas inside of circuits. If a power shortage occurs and recovers in a short time, it will cause damage to your connected appliances. To prevent this kind of damage, please check manufacturer of air conditioner if it's equipped with time-delay function before installation. Otherwise, this inverter will be triggered overload fault and cut off output to protect your appliance but sometimes it still causes internal damage to the air conditioner.

PV Connection

CAUTION: Before connecting to PV modules, please install separately a DC circuit breaker between inverter and PV modules.

WARNING! All wiring must be performed by a qualified personnel.

WARNING! It's very important for system safety and efficient operation to use appropriate cable for PV module connection. To reduce risk of injury, please use the proper recommended cable size as below.

Model	Typical Amperage	Cable Size	Torque
4-6KW	60A	1*8 AWG	1.4~1.6 Nm
8-12KW	60A	1*8 AWG	1.6~1.8 Nm
8-12KW	2*60A	2*8 AWG	2~3 Nm

PV Module Selection:

When selecting proper PV modules, please be sure to consider below parameters:

1. Open circuit Voltage (Voc) of PV modules not exceeds max. PV array open circuit voltage of inverter.
2. Open circuit Voltage (Voc) of PV modules should be higher than min. battery voltage.

Solar Charging Mode	
INVERTER MODEL	4-12KW
Max.PV Array Open Circuit Voltage	145Vdc
PV Array MPPT Voltage Range	60Vdc-130Vdc
Min Battery Voltage For PV Charge	Battery voltage + 3Vdc

Please follow below steps to implement PV module connection:

1. Remove insulation sleeve 10 mm for positive and negative conductors.
2. Check correct polarity of connection cable from PV modules and PV input connectors. Then, connect positive pole (+) of connection cable to positive pole (+) of PV input connector. Connect negative pole (-) of connection cable to negative pole (-) of PV input connector.

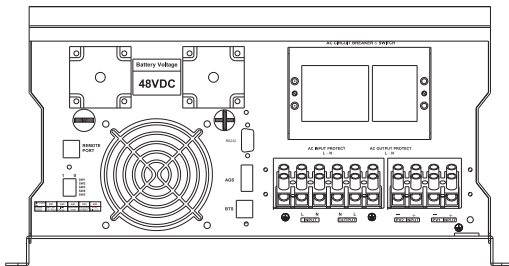

3. Make sure the wires are securely connected.

Display Data

The LCD display information will be switched in turns by pressing "UP" or "DOWN" key. The selectable information is switched as below order: battery voltage, battery current, inverter voltage, inverter current, inverter frequency, grid voltage, grid current, grid frequency, temperature, load in Watt, PV voltage, MPPT charging power, MPPT charging output voltage, MPPT charging current.(PV2 voltage)

Selectable information	LCD display
Battery voltage/Battery current	
Inverter output voltage/Inverter output current	
Grid voltage/Grid current	

Operating Mode Description

Operation mode	Description	LCD display
Match load mode Note: DC power produced from your solar array is converted by the inverter into AC power, which is then sent to your main electrical panel to be used by your household appliances. Another power supplying source is the bypass circuit connected with grid.	PV energy is charger into the battery or converted by the inverter to the AC load.	PV energy power is larger than inverter power
		PV energy power is smaller than inverter power
		PV is off
Charge mode	PV energy and utility can charge batteries. The total charging current is the adding of PV charging current and grid charging current.	
Bypass mode Note: Bypass mode: Error are caused by inside circuit error or external reasons such as over temperature, output short circuited and so on	Utility can power loads when the unit starts up without battery.(Only available in 4K/5K model with single operation)	
Off-Grid mode	The inverter will provide output power from battery and PV power if the grid power is abnormal.	Inverter power loads from PV energy.
		Inverter power loads r from battery and PV energy.
		Inverter power loads from battery only.
Power Saver Mode	The inverter stop working if you turn off the inverter by the soft key or error has occurred in the condition of no grid.	

PV Wiring

Wiring option 2 4-6KW MPPT 60A PV Input	
Wiring option 3 8-12KW MPPT 60A PV Input	
Wiring option 4 8-12KW MPPT 120A PV Input	

Electrical Performance

Topology

The inverter/charger is built according to the following topology.

Inverter: Full Bridge Topology.

AC Charger: Isolate Boost Topology

Solar Charger: MPPT solar Controller

Because of high efficiency Mosfets and 32bit,60MHz DSP and heavy transformers, it outputs PURE SINE WAVE AC with an average THD of 10% (min5%,max15%) depending of load connected and battery voltage.

The peak efficiency of the inverter is 88%.

AC Charger

The inverter is equipped with an active PFC (power factor corrected) multistage battery charger. The PFC feature is used to control the amount of power used to charge the batteries in order to obtain a power factor as close as possible to 1.

Unlike other inverters whose max charging current decreases according to the input AC voltage, the charger is able to output max current as long as input AC voltage is in the range of 170-260 VAC.

The inverter is with a strong charging current of 100Amp(for 12KW,48V),and the max charge current can be adjusted from 0%-100% via a liner switch at the right of the battery type selector. This will be helpful of you are using our powerful charger on a small capacity battery bank. Fortunately, the liner switch can effectively reduce the max charging current to 20% of its peak. Choosing the battery type selector will disable charging function.

There are mainly 3 stages:

Bulk Charging: This is the initial stage of charging. While Bulk Charging, the charger supplies the battery with controlled constant current. The charger will remain in Bulk charge until the absorption charge voltage (determined by the Battery Type selection)is achieved.

Absorb Charging: This is the second charging stage and begins after the absorb voltage has been reached. Absorb charging provides the batteries with a constant voltage and reduces the DC charging current in order to maintain the absorb voltage setting.

In this period, the inverter will start a T1 time; the charger will keep the boost voltage in Boost CV mode until the T1 time has run out. Then drop the voltage down to the float voltage. The timer has a minimum time of 1 four and a maximum time of 12 hours.

Float Charging: The third charging stage occurs at the end of the Absorb Charging time. While Float charging, the charge voltage is reduced to the float charge voltage (determined by the battery type selection*). In this stage, the battery are kept fully charged and ready if needed by the inverter.

If the A/C is reconnected or the battery voltage drops below 12VDC/24VDC/48VAC, the charger will reset the cycle above.

In battery mode, it will present battery capacity.		
Load Percentage	Battery Voltage	LCD Display
Load >50%	< 1.717V/cell	
	1.717V/cell ~ 1.8V/cell	
	1.8 ~ 1.883V/cell	
	> 1.883 V/cell	
50% > Load > 20%	< 1.817V/cell	
	1.817V/cell ~ 1.9V/cell	
	1.9 ~ 1.983V/cell	
	> 1.983	
Load < 20%	< 1.867V/cell	
	1.867V/cell ~ 1.95V/cell	
	1.95 ~ 2.033V/cell	
	> 2.033	

Load Information				
	Indicates overload.			
	Indicates the load level by 0-24%, 25-50%, 50-74% and 75-100%.			
	0%~25%	25%~50%	50%~75%	75%~100%

Mode Operation Information	
	Indicates unit connects to the mains.
	Indicates unit connects to the PV panel.
	Indicates load is supplied by utility power.
	Indicates the utility charger circuit is working.
	Indicates the DC/AC inverter circuit is working.

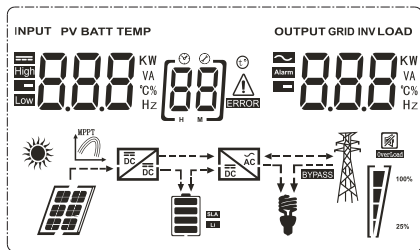

Icon	Function description	
Input Source Information and Output Information		
	Indicates the AC information	
	Indicates the DC information	
	Indicate input voltage, input frequency, PV voltage, battery voltage and charger current. Indicate output voltage, output frequency, load in VA, load in Watt and discharging current.	
Configuration Program and Fault Information		
	Indicates the warning and fault codes. Warning: flashing with warning code. Fault: lighting with fault code	
Battery Information		
	Indicates battery level by 0-24%, 25-49%, 50-74% and 75-100% in battery mode and charging status in line mode.	
In AC mode, it will present battery charging status.		
Status	Battery voltage	LCD Display
Constant Current mode / Constant Voltage mode	<2V/cell	4 bars will flash in turns.
	2 ~ 2.083V/cell	Bottom bar will be on and the other three bars will flash in turns.
	2.083 ~ 2.167V/cell	Bottom two bars will be on and the other two bars will flash in turns.
	> 2.167 V/cell	Bottom three bars will be on and the top bar will flash.
Floating mode. Batteries are fully charged.		4 bars will be on.

Table 2.5.1 battery charging processes

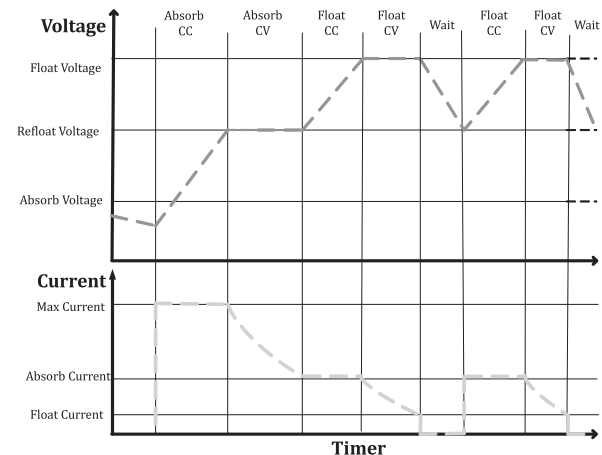

Table 2.5.2 battery type selector

Switch Setting	Description	Fast Mode/VDC	Float Mode/VDC
0,9	Charger Off		
1	Gel USA	14.0	13.7
2	AGM 1	14.1	13.4
3	AGM2	14.6	13.7
4	Sealed Lead Acid	14.4	13.6
5	Gel EURO	14.4	13.8
6	Open Lead Acid	14.8	13.6
7	Sealed Lead Acid	14.4	13.6
8	Sealed Lead Acid	14.4	13.6

For 12VDC mode series (*2FOR 24VDC mode; *4 for 48VDC mode)

Charging depleted batteries

The inverter allows start up and through power with depleted batteries.

For 12VDC model, after the battery voltage goes below 10V, if the switch is still (and always) kept in :ON position, the inverter is always connected with battery, and the battery voltage does not drop below 2V, the inverter will be able to charge the battery once qualified AC inputs are present.

Before the battery voltage goes below 9VDC, the charging can be activated when the switch is turned to "Off", the to "ON".

When the voltage goes below 9VDC, and you accidentally turn the switch to OFF or disconnect the inverter from battery, the inverter will not be able to charge the battery once again, because the CPU loses memory during this process.

Table 2.5.3 AC charging current for the model

Model watt (KW)	Battery voltage (VDC)	AC charger current max (Amp)	Model watt (KW)	Battery voltage (VDC)	AC charger current max (Amp)
4.0	24	65±5	5.0	24	80±5
	48	40±5		48	50±5
6.0	24	90±5	8.0	48	70±5
	48	60±5		48	100±5
10.0	48	80±5	12.0	48	100±5

The charging capacity will go to peak in around 3 seconds. This may cause a generator to drop frequency, making inverter transfer to battery mode.

It is suggested to gradually put charging load on the generator by switching the charging switch from min to max, together with the 15s switch delay, our inverter gives the generator enough time to spin up. This will depend on the size of the generator and rate of charge.

Solar charger:

The inverter has two solar chargers for 8KW/10KW/12KW, and one solar charger for 6KW below. Each solar charger have a charging current of 60Amp Max .They provide current to the battery set together with the AC charger.

Unlike other combination mode, the charging current of Solar charger and the AC charger is not only adding together simply. Under the premise of a constant total current value , they can change intelligently, however, at any time the current of Solar charger is bigger than AC charger if the voltage of Solar charger is at normal limits, and the total charging current is less than allowable maximal current.

Maximum Power Point Tracking (MPPT) Function

Maximum Power Point Tracking, frequently referred to as MPPT, is an electronic system that operates the photovoltaic (PV) modules in a manner that allows the modules to produce all the power they are capable of. The PV-seeker charge controller is a microprocessor-based system designed to implement the MPPT. And it can increase charge current up to 30% or more compared to traditional charge controllers (See table 2.5.4).

Table 2.5.4 current, power Vs. Voltage characteristics

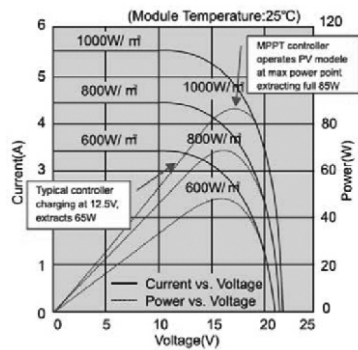

Remote control

Apart from the switch panel on the front of the inverter, an switch panel connected to the RJ11 port at the DC side of the inverter thru a standard telephone cable can also control the operation of the inverter. If an extra switch panel is connected to the inverter via "remote control port" together with the panel on the inverter case, the two panels will be connected and operated in parallel.

Whichever first switches from "off" to "Power saver off" or "Power saver on" it will power the inverter on. If the commands from the two panels conflict, the inverter will accept command according to the following priority:

Power saver on > Power saver off > Power off

Only when both panels are turned to "Unit Off" position will the inverter be powered off.

The Max length of the cable is 10 meters.



WARNING!

Never cut the telephone cable when the cable is attached to inverter and battery is connected to the inverter. Even if the inverter is turned off. It will damage the remote PCB inside if the cable is short circuited during cutting.

Auto generator start (AGS)

There is an extra connector in front of the inverter used to start the generator. If the utility power is abnormal and single battery discharges below 11Vdc, the inverter will send out a signal to the cable of the connector which is cascaded to the control circuit of the generator, owing to this the control circuit will get through and then generator will be started. if single battery is charged higher than 13.5Vdc, the signal will disappear to make the generator keeping closed again.

LED Indicator

Table 2.5.7 LED Indicators

Line mode	Yellow LED light AC mode
Inverter mode	Green LED light in inverter mode
Fast charger	Green LED light in fast charging mode
Float charger	Green LED light in float charging mode
Alarm mode	Red LED light in error state
Over temp trip	Red LED light in over temperature
Over load trip	Red LED light in over load
Solar charger mode	Green LED light in solar charger mode

When in the search sense mode, the green power LED will blink and the inverter will make a ticking sound. At full output voltage, the green power LED will light steadily and the inverter will make a steady humming sound. When the inverter is used as an "Uninterruptible" power supply the search sense mode or "Power Saver Auto" function should be defeated.

Exceptions

Some devices when scanned by the load sensor cannot be detected. Small fluorescent lights are the most common example. (Try altering the plug polarity by turning the plug over.) Some computers and sophisticated electronics have power supplies that do not present a load until line voltage is available. When this occurs, each unit waits for the other to begin. To drive these loads either a small companion load must be used to bring the inverter out of its search mode, or the inverter may be programmed to remain at full output voltage.

Protections

The inverter is equipped with extensive protections against various situations/faults. These protections include:

AC Input over voltage protection/AC Input low voltage protection

Low battery voltage protection/High battery voltage protection

Over temperature protection/Over load protection

Short Circuit protection

When Over temperature/Over load occur, after the fault is cleared, the master switch has to be reset to restart the inverter.

The Low batter voltage trip point can be customized from defaulted 10VDC to 10.5VDC through the SW1 on DIP switch.

The inverter will go to Over temp protection when heat sink temp $\geq 95^{\circ}\text{C}$, and go to Fault(shutdown Output) after 30 seconds. The switch has to be reset to activate the inverter.

The Global LF series Inverter has back feeding protection which avoids presenting an AC voltage on the AC input terminal in Invert mode.

After the reason for fault is cleared, the inverter has to be reset to start working.

The charge controller built in is with 12/24/48V battery voltage auto detecting function.

For 12/24VDC inverter, the output voltage of solar charger will be accordingly 12/24VDC, and the qualified DC input bolt range is 15-145VDC.

For 48VDC inverter, the output voltage of solar will be accordingly 48VDC, and the qualified DC input volt range is 64-145VDC.

If the voltage falls out of this range, the charger will not work properly. Special attention should be paid to this when configuring the solar array.

NOTE:

① The optional battery temperature sensor automatically adjusts the charging process of the controller according to the type of battery that is selected by user through battery type selector. With the battery temperature sensor installed, the controller will increase or decrease the battery charging voltage depending on the temperature of the battery to optimize the charge to the battery and maintain optional performance of the battery.

Transfer

While in the standby mode, the AC input is continually monitored. Whenever AC power falls below the VAC Trip voltage (154VAC, default setting for 230VAC), the inverter automatically transfers back to the invert mode with minimum interruption to your appliances as long as the inverter is turned on. The transfer from standby mode to inverter mode occurs in approximately 8 milliseconds. And it is the same time from inverter mode to standby mode.

There is a 15-second delay from the time the inverter senses that continuously qualified AC is present at the input terminals to when the transfer is made. This delay is built in to provide time for a generator to spin-up to a stable voltage and avoid relay chattering. The inverter will not transfer to generator until it has locked onto the generator's output. This delay is also designed to avoid frequent switching when input utility is unstable.

Automatic Voltage Regulation

The automatic voltage regulation function is for full series of pure sine wave inverter/charger except split phase models including 4000W-12000W.

AC voltage to a range of 230V±10%.

Connected with batteries, the inverter will function as a UPS with max transfer time of 10ms. With all the unique features our inverter provides, it will bring you long-term trouble free operation beyond your expectation.

Power Saver Mode

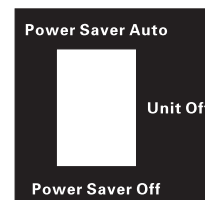

There are 3 different status for inverter: "Power Saver Auto " "Power Saver Off" and "Unit off"

When power switch is in "Unit Off"position, the inverter is powered off.

When power switch is turned to either of "Power Saver Auto"or "Power Saver Off", the inverter is powered on.

Power saver function is designed to conserve battery power when AC power is not or rarely required by the loads.

In this mode, the inverter pulses the AC load (i.e., electrical appliance). Whenever an AC load (greater than 25 watts) is turned on, the inverter recognizes the need for power and automatically starts inverting and output goes to full voltage. When there is no load (or less than 25 watts) detected, the inverter automatically goes back into search mode to minimize energy consumption from the battery bank. In "Power save on" mode, the inverter will draw power mainly in sensing moments, thus the idle consumption is significantly reduced.

The inverter is factory defaulted to detect load for 250ms every 5seconds. This cycle can be customized to 30 seconds turn SW3 on the DIP switch.

Note: The minimum power of load to take inverter out of sleep mode (Power Saver On) is 25 Watts.

Table 2.5.6 Idle Power Consumption

Model	Power Saver Off	Power Saver Auto	
	Idle	30Secs(Max)	Stand-By Mode
4000W	90W	20W	6.6W
5000W	100W	20W	6.6W
6000W	120W	25W	6.6W
8000W	160W	25W	6.6W
10000W	180W	25W	6.6W
12000W	180W	25W	6.6W